

⚠ Cautions & Warnings

- Use the originally supplied power supply only.
- Do not use an extension cable in any case whatsoever.
- Ensure the electrical outlet is protected by a ground fault interrupter (GFI) or an earth leakage interrupter.
- Ensure that the power supply is not in a wet environment.
- Do not enter the pool while the pool cleaner is in the water.
- Unplug the power supply before servicing.
- Do not use the cable to take the pool cleaner out of the water.
- Use the Pool Cleaner in the following water conditions only: Chlorine Max 4 ppm; pH 7.0 - 7.8; Temperature 6 -35°C (43-95°F); NaCl Maximum = 5000 ppm.
- Keep the Robotic Pool Cleaner out of the reach of children or persons with reduced physical, sensory, or mental capabilities, or lack of experience and knowledge, unless they have been given supervision or instruction.

Digital Power Supply

Input: 100-250 AC Volts
50-60 Hertz 2A
Output: <30 VDC 6A 180W
IP 54

Specifications:

Motor protection: IP 68
Minimum depth: 0.4m/1.33ft
Maximum depth: 5m/16.4ft

i Recommendation

- The power supply should be placed in a well ventilated and shaded location.
- If the Dolphin is fitted with combined or wonder brushes, gently squeeze the brushes until they are soaked with water and only then start the cleaning process.
- Release minimal required floating cable length to ensure proper pool coverage. Leave excess cable rolled outside the pool.
- After each cleaning cycle wash the filters or cartridge. Clogged filters reduce scanning and cleaning efficiency.
- In case the cable has some kinks, stretch it out completely and let it sit for at least a day in the sun.
- Store the pool cleaner in a shady place on the caddy.

Operating the robot using the MyDolphin™ Plus app

- Plug in the power supply.
- Download the MyDolphin™ Plus app.
- Activate Bluetooth® and Wi-Fi® on your smart device.
- Start the registration process.
- Scan the QR code printed on the power supply, and complete the process.
- Follow the instructions as showed in the app.



For online product warranty registration:
registration.maytronics.com

maytronics | 

Quick start guide

M700



Thank you for purchasing a Maytronics Dolphin Robotic Pool Cleaner.

The Robotic Pool Cleaners by Maytronics deliver advanced cleaning technologies, long lasting performance and easy maintenance. You and your family will be free to enjoy swimming with full confidence that your pool is completely clean.



For a detailed manual (including videos):
manuals.maytronics.com/en/99996710-NZ



Robot operation

Set Up

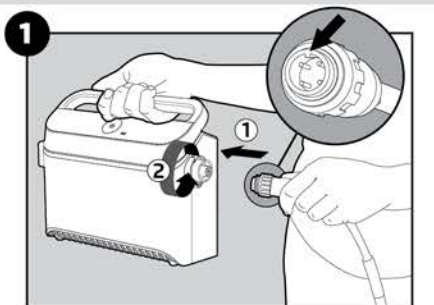

Connect the floating cable to the power supply.

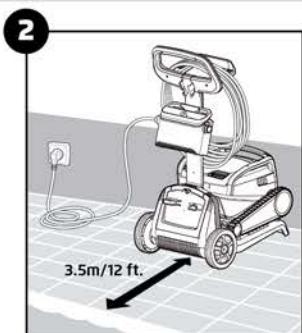

Position the power supply at least 3.5m/12ft away from the edge of the pool.

Into the pool



Put the pool cleaner in the pool and let it sink to the floor. Make sure that the floating cable is free of any obstructions.

Operation

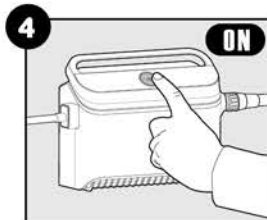

Turn the power supply ON. The pool cleaner will now operate until it has reached the end of the cleaning cycle.

Out of the pool

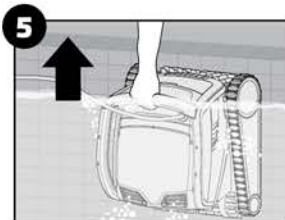

Use the robot's handle to pull it out from the pool.

6 Cleaning the filter

It is highly recommended to clean the filter basket after each cleaning cycle.

Note: Don't let the filter cartridges dry out before cleaning.

⚠ Unplug the power supply before servicing

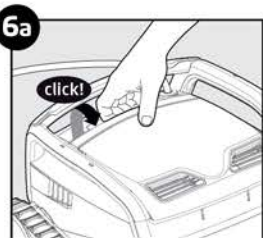

Open the robot's cover.

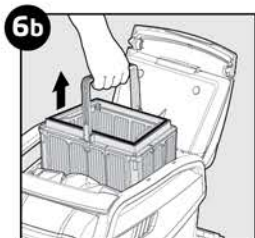

Lift the basket.

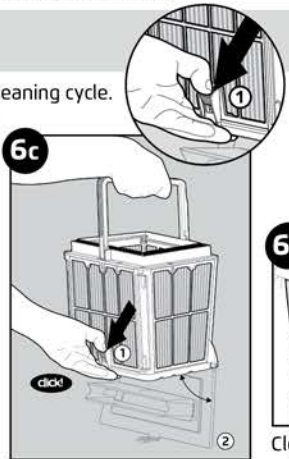

Open the latch to release the bottom lid in order to remove the debris.

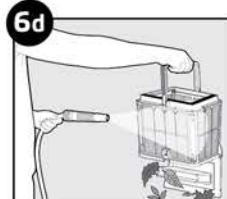

Clean the filter basket with a hose.

Storage

7 Coil the cable and store in a cool, dry place. Do NOT store the robot and its accessories where it will be exposed to direct sunlight, excessive heat or to frost.

Maintenance

Periodic filter cleaning

Dismantle the 4 ultra-fine filter panels of the outer basket according to the following steps:



Hold down the handle and remove the inner net.

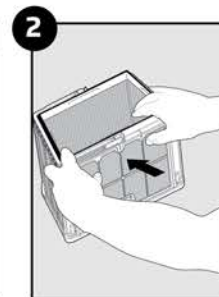

Dismantle the panels, starting with pressing on panel no.1 using your thumbs.

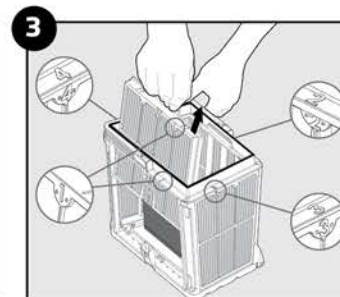

Continue to dismantle the panels in the order of their numbers: no.2--> no.3--> no.4.

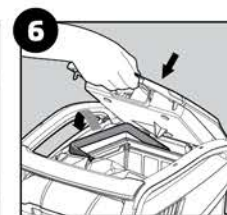
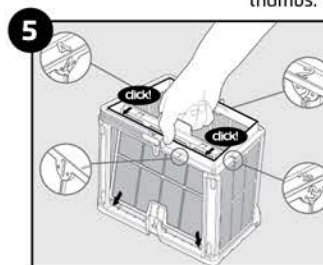
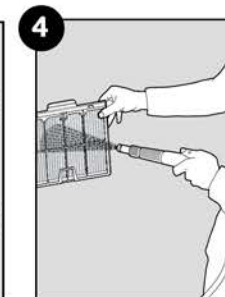

Insert the clean filter basket and close the robot's cover.

Start the season with the net filters for large debris then use ultra-fine filters for daily use.



* The net filters are assembled in the filter basket.

Cleaning the impeller

If you notice debris trapped in the impeller:

⚠ Unplug the power supply before servicing

Clean the debris trapped in the impeller opening, according to the following steps:

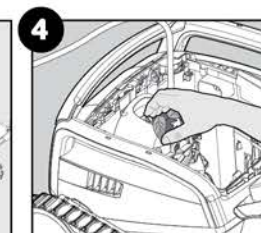
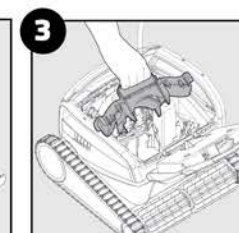
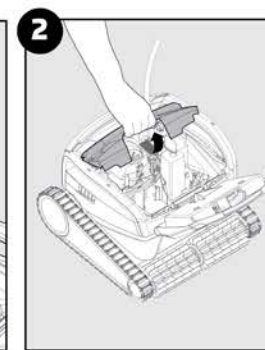
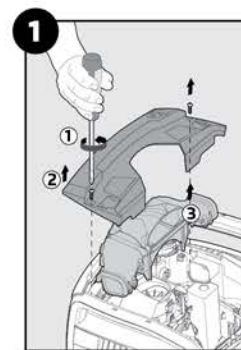

Be sure to assemble back in the same order.

For a detailed manual (including videos):

manuals.maytronics.com/en/99996710-NZ

maytronics

